

S&C Track Plans

This guide contains the track plans for stations, junctions, and sidings along the Skipton to Carlisle route included in Trainz Classics 3

Skipton

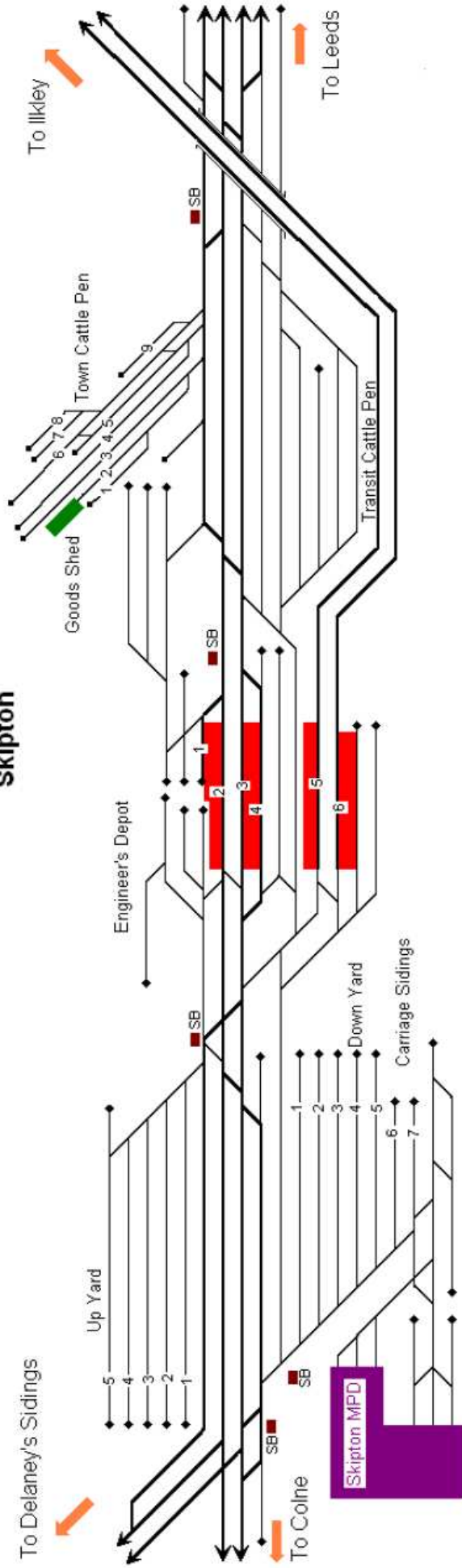

Delaney's Sidings

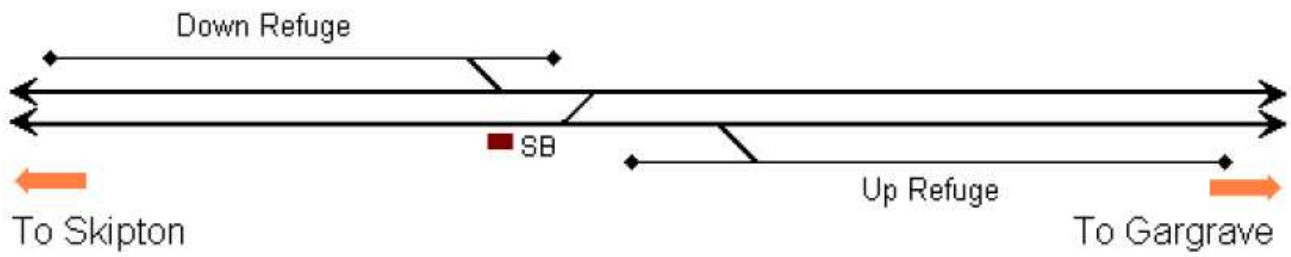

Gargrave

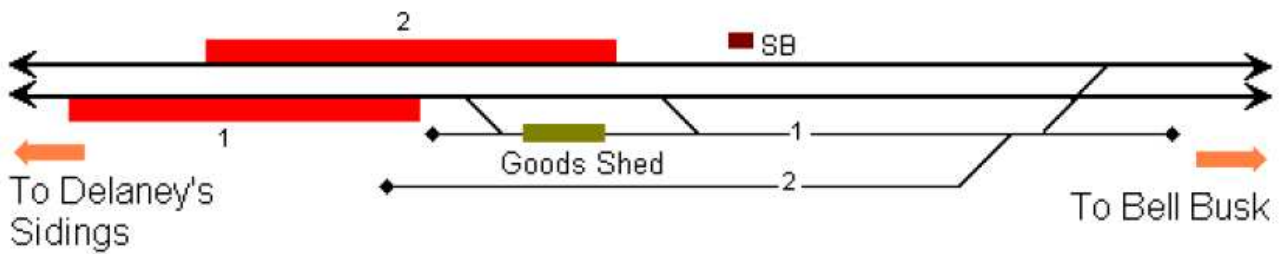

Bell Busk

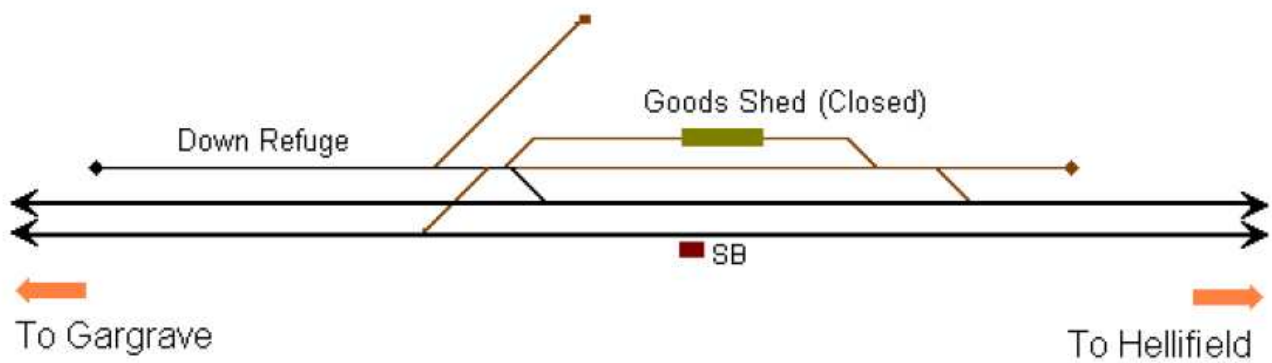

Hellifield

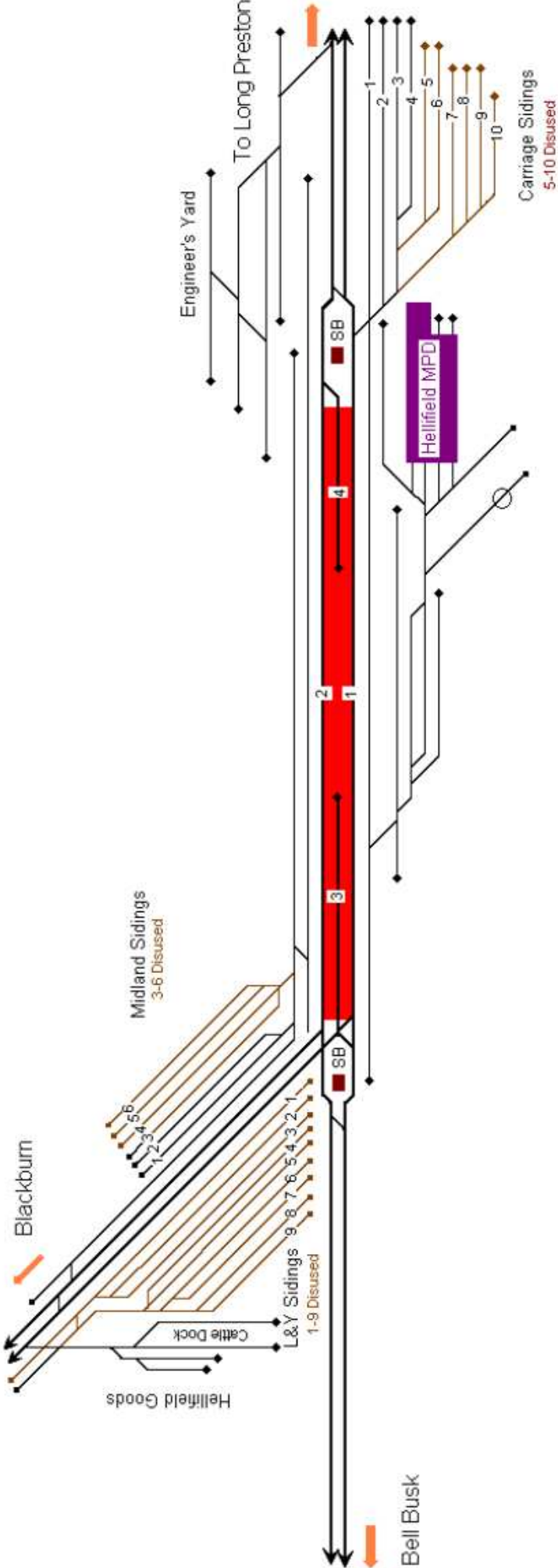

Long Preston

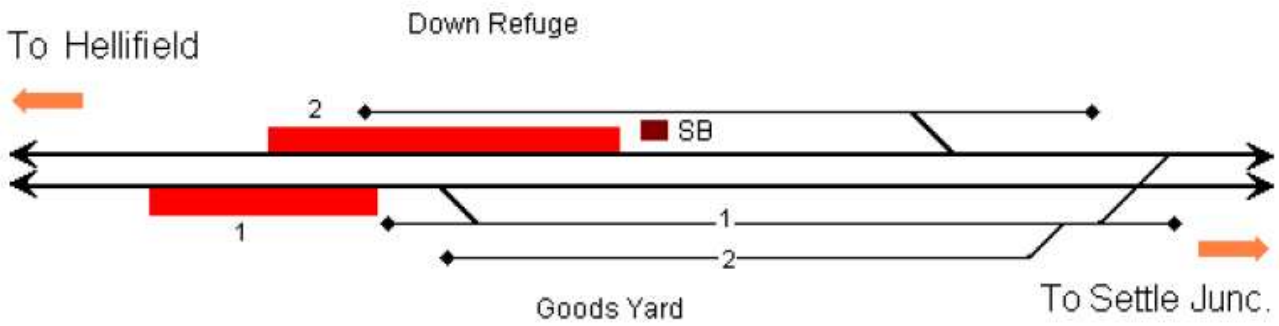

Settle Junction

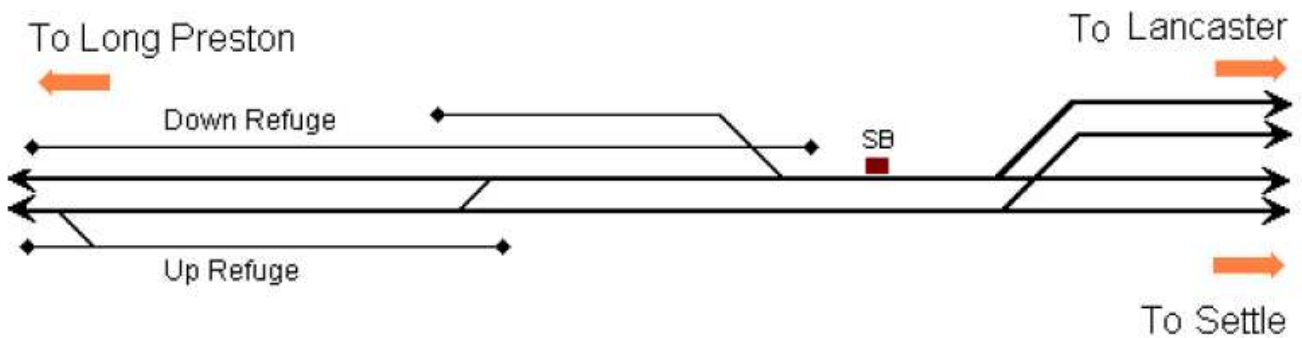

Settle

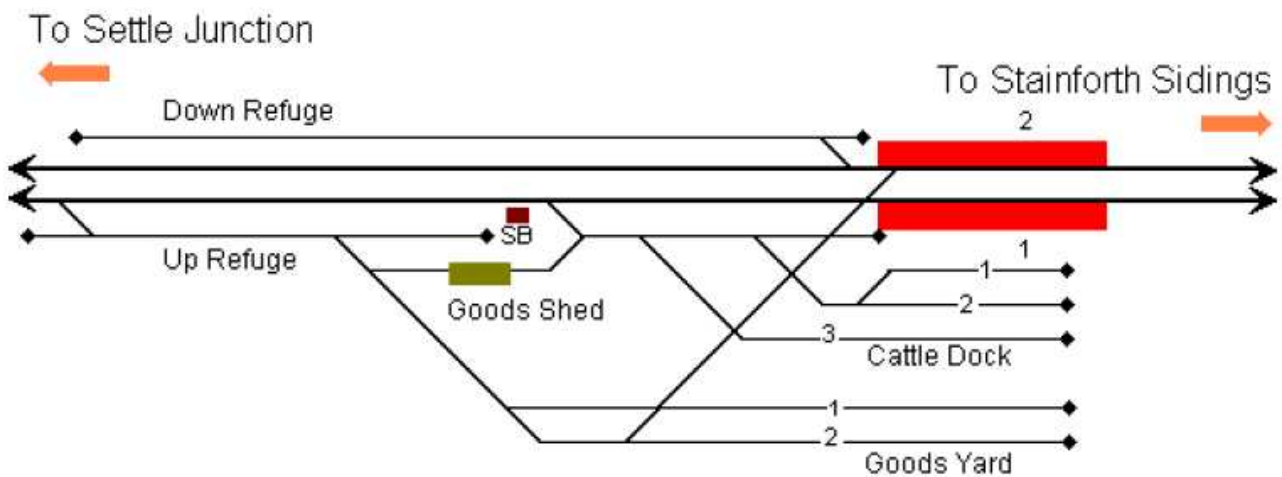

Stainforth Sidings

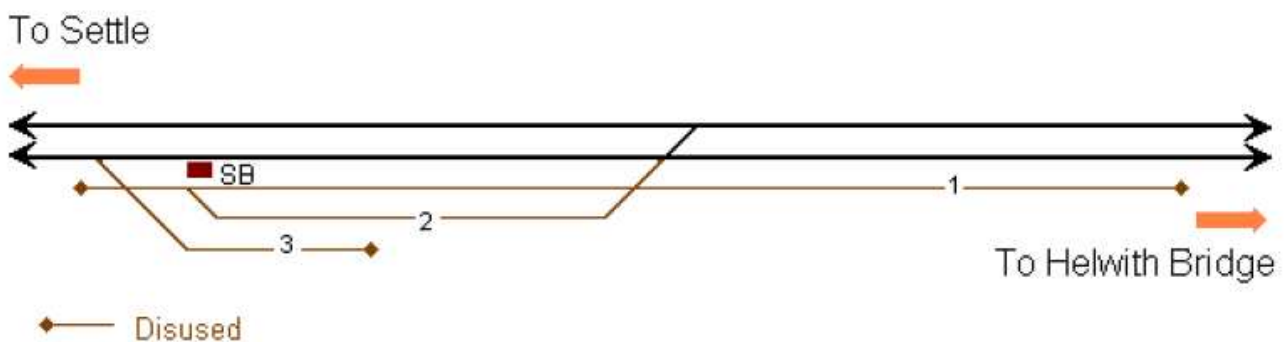

Helwith Bridge

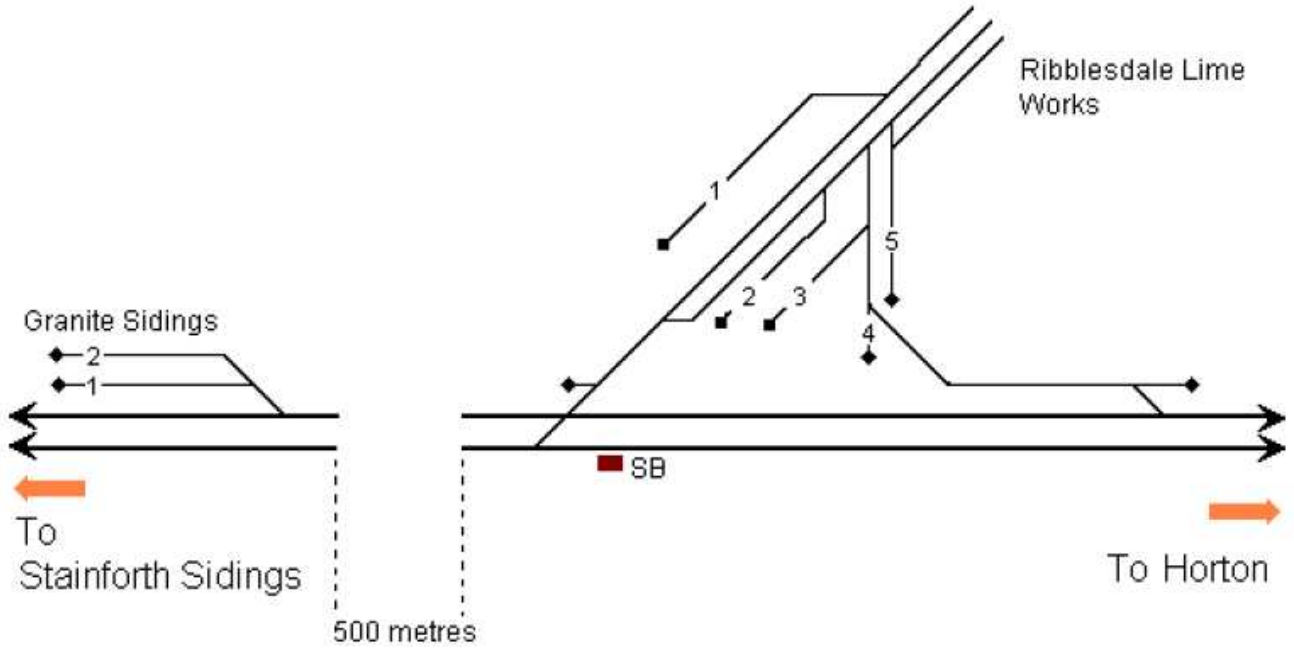

Horton-in-Ribblesdale

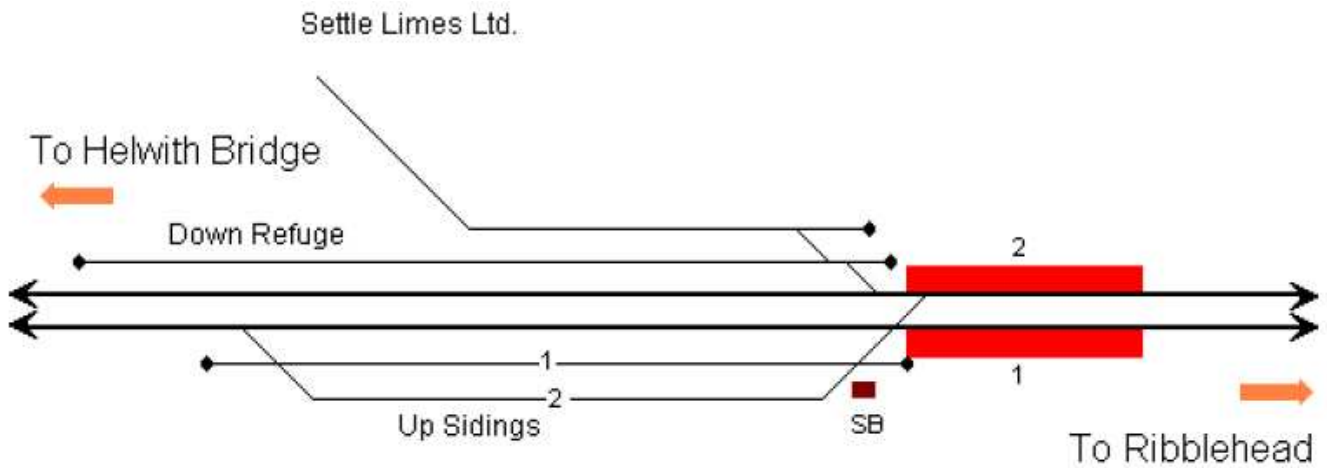

Ribblehead

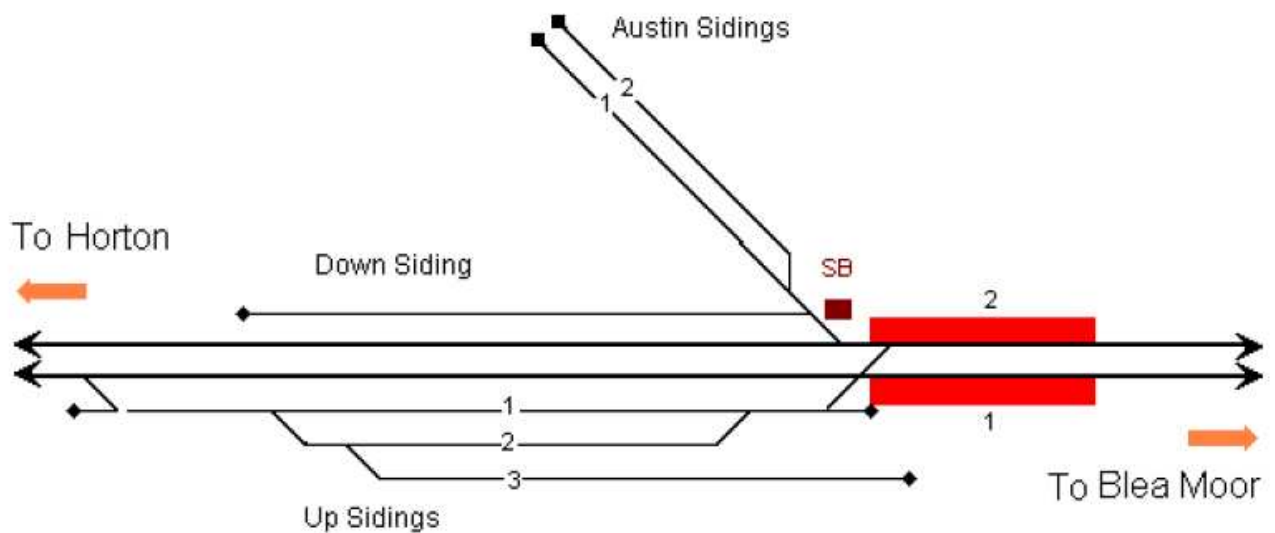

Dent

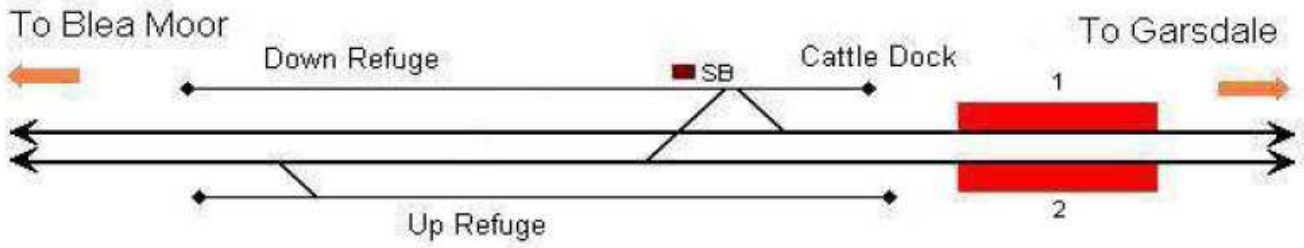

Garsdale

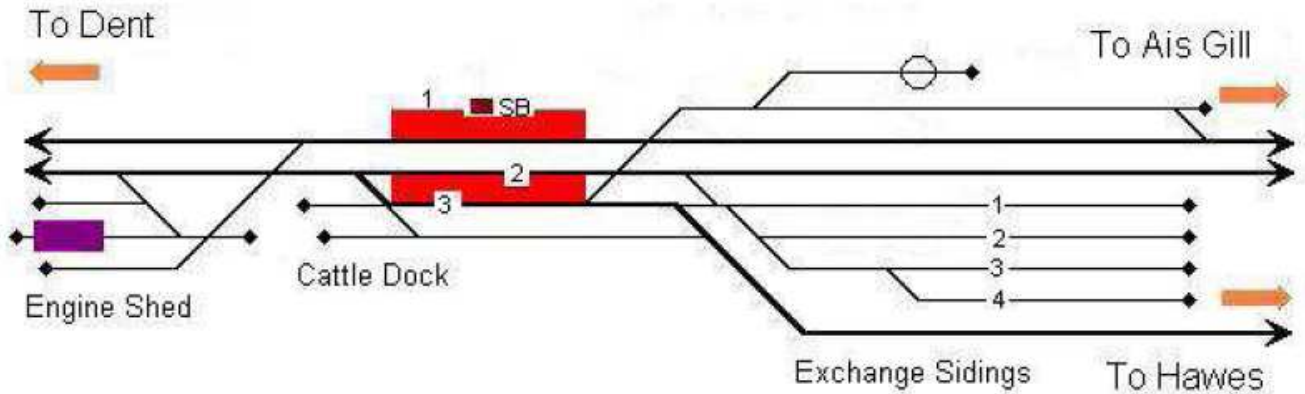

Hawes

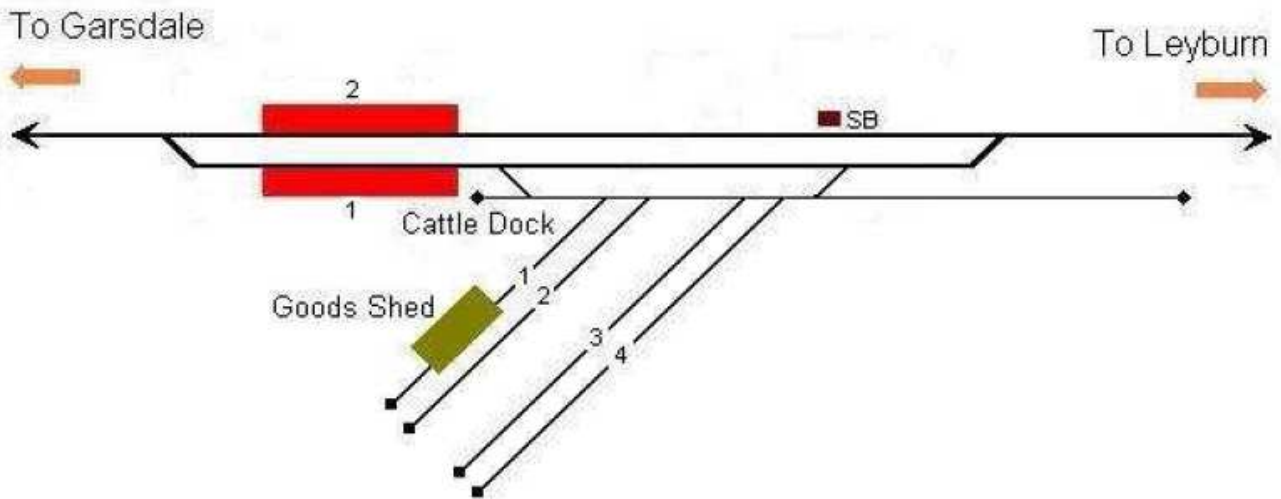

Ais Gill

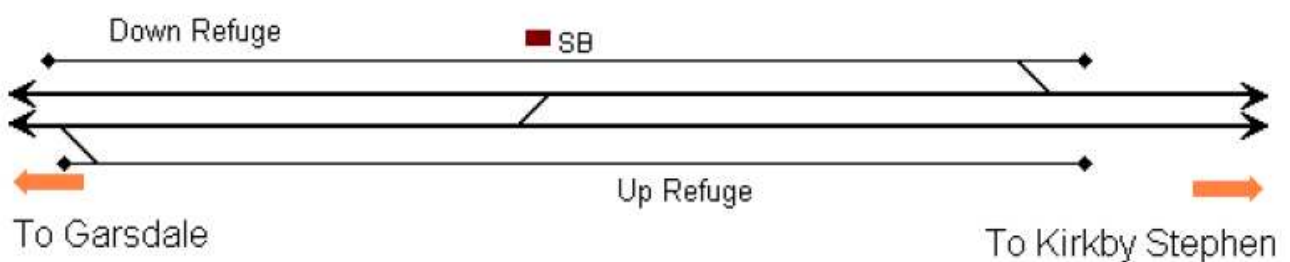

Kirkby Stephen

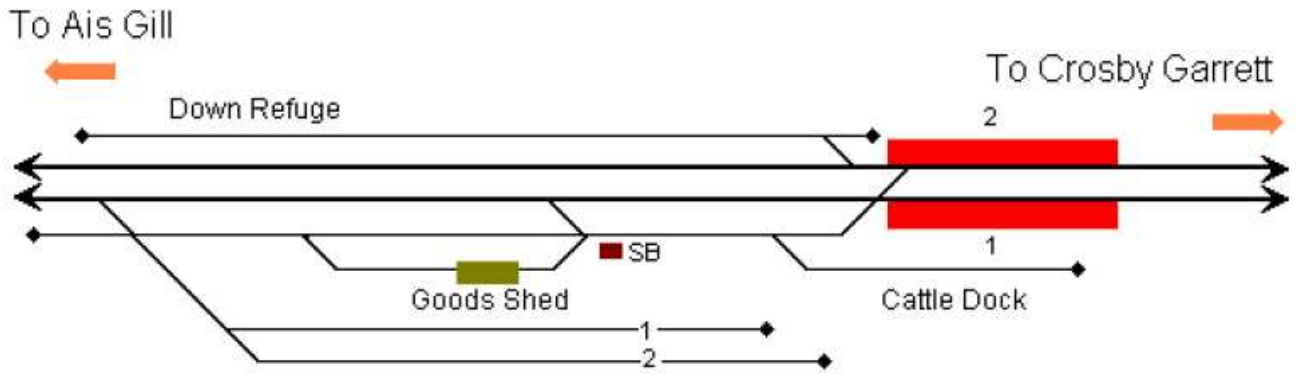

Crosby Garrett

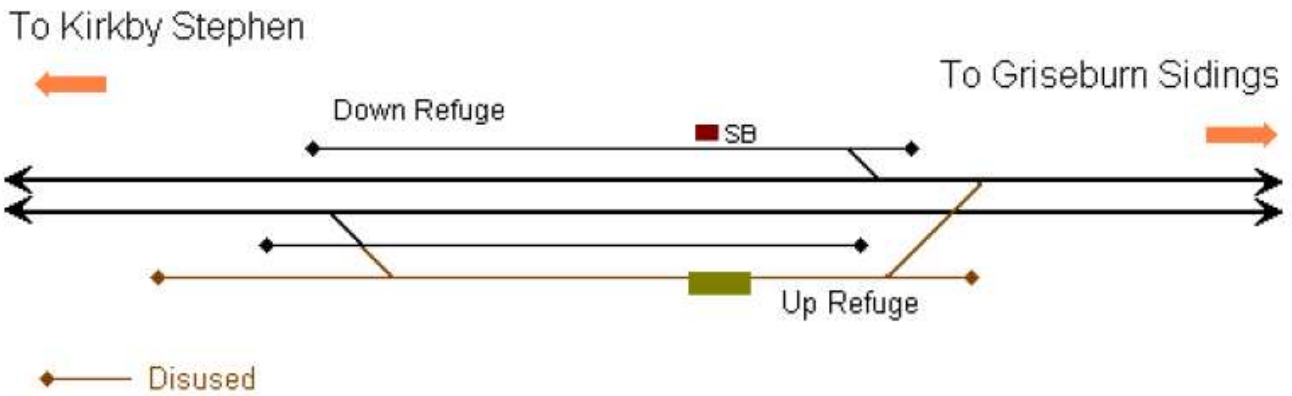

Griseburn Ballast Sidings

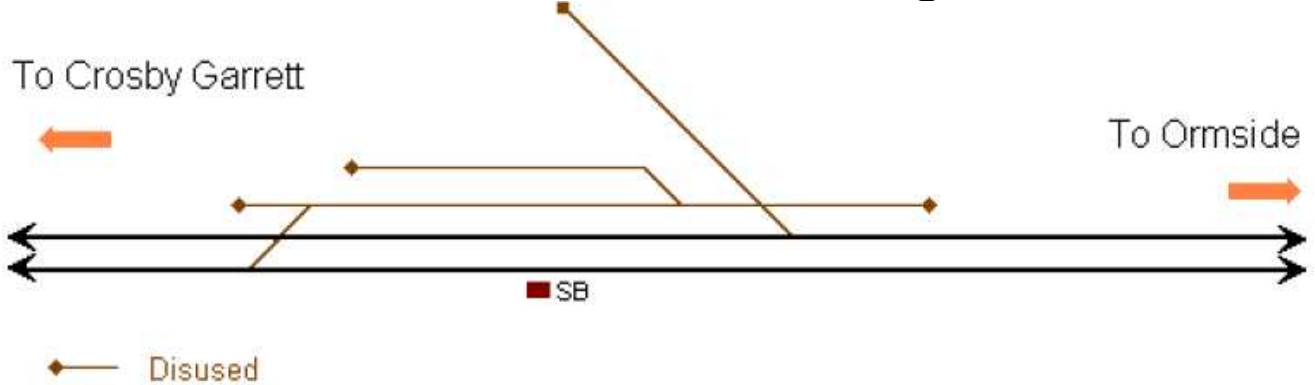

Appleby

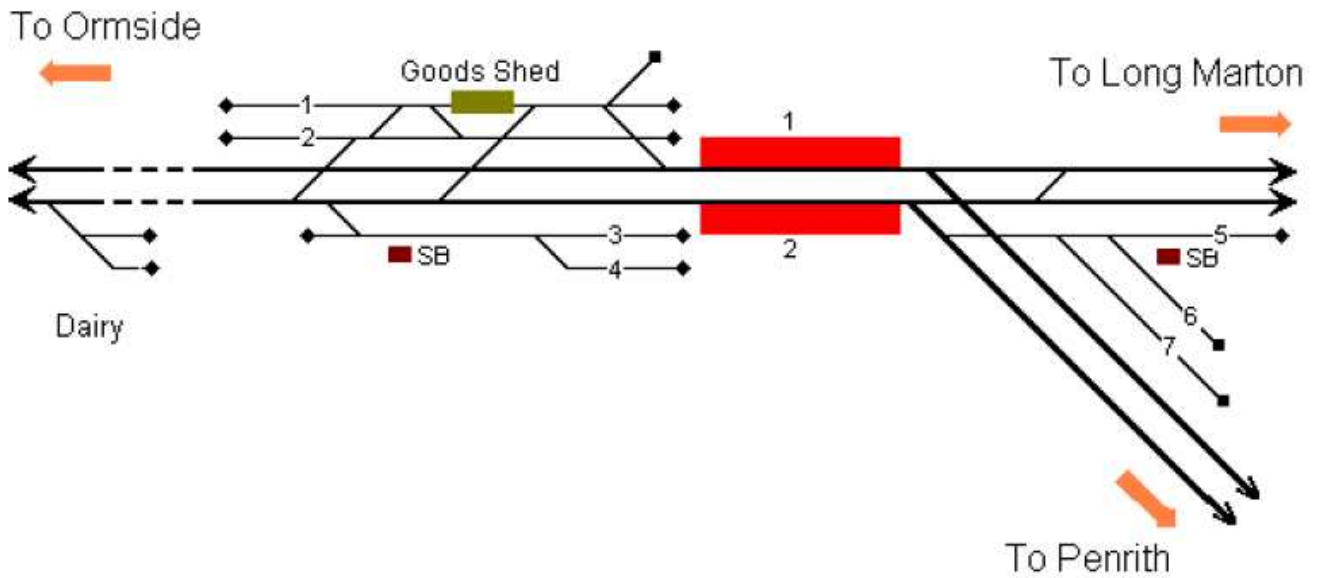

Long Marton

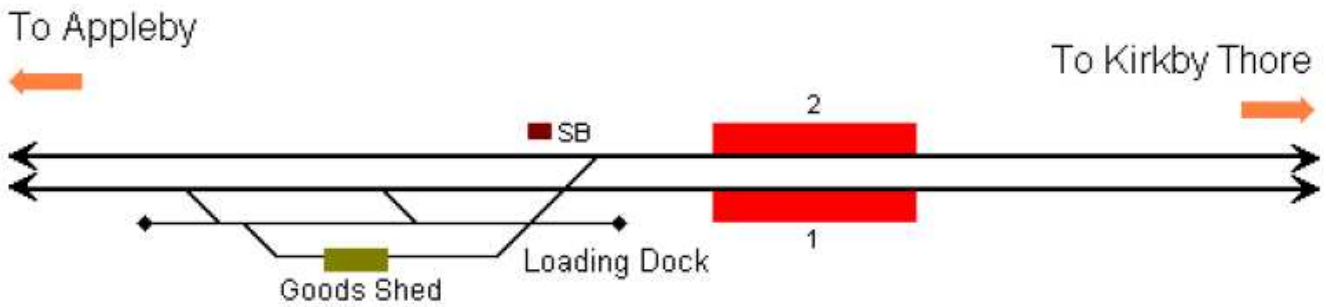

Kirkby Thore plasterboard works

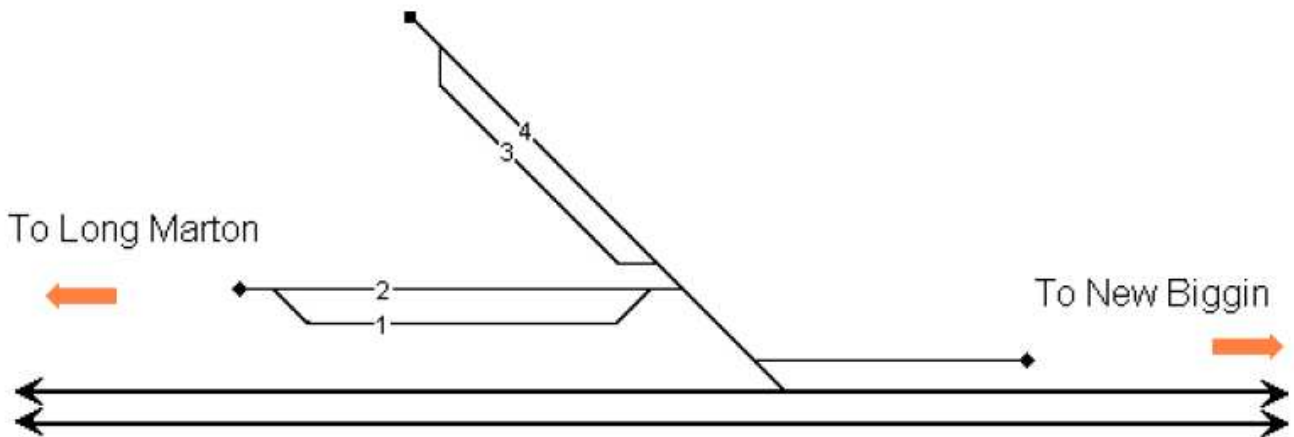

New Biggin

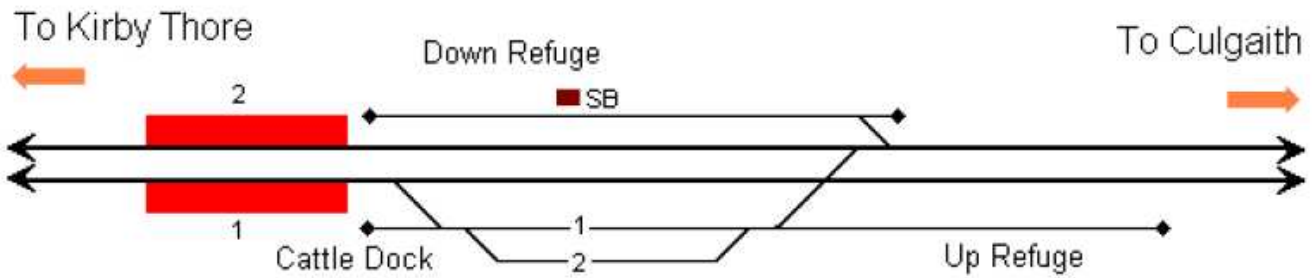

Culgaith

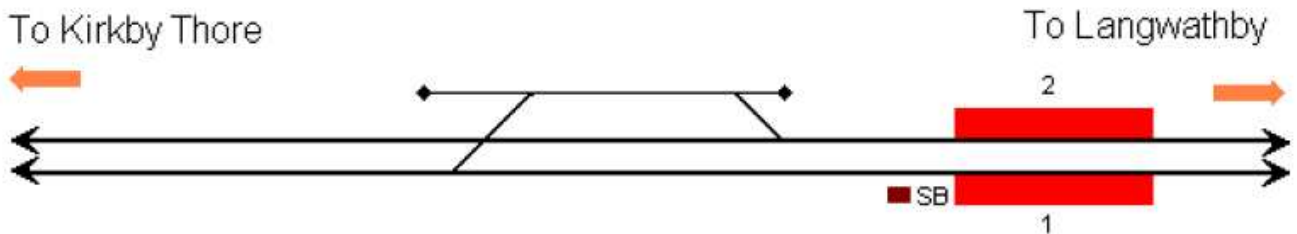

Langwathby

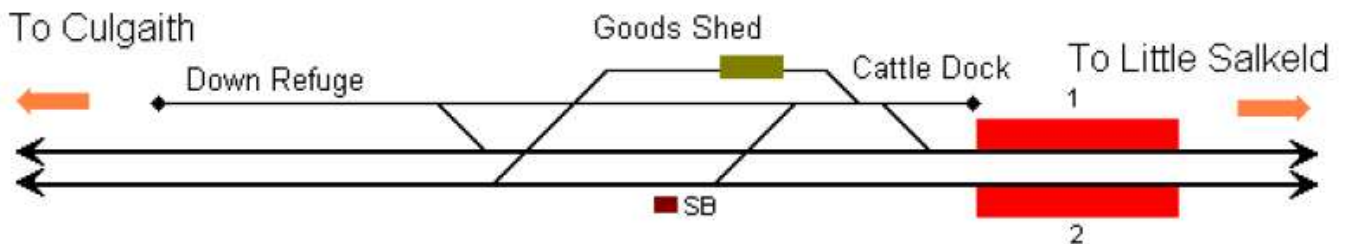

Little Salkeld

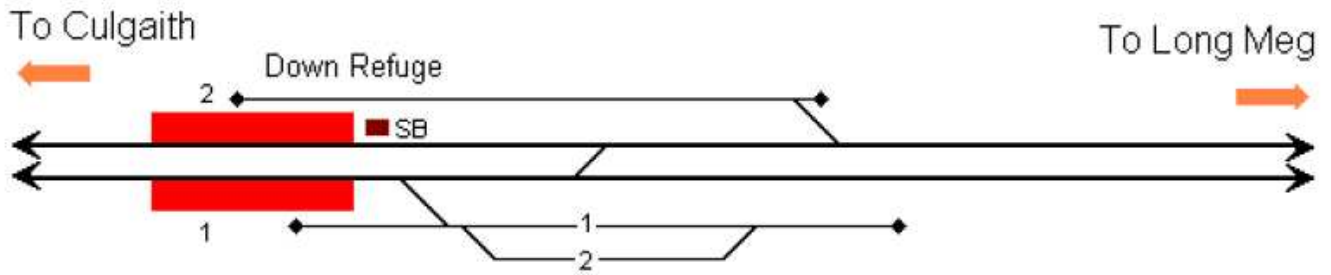

Long Meg Sidings

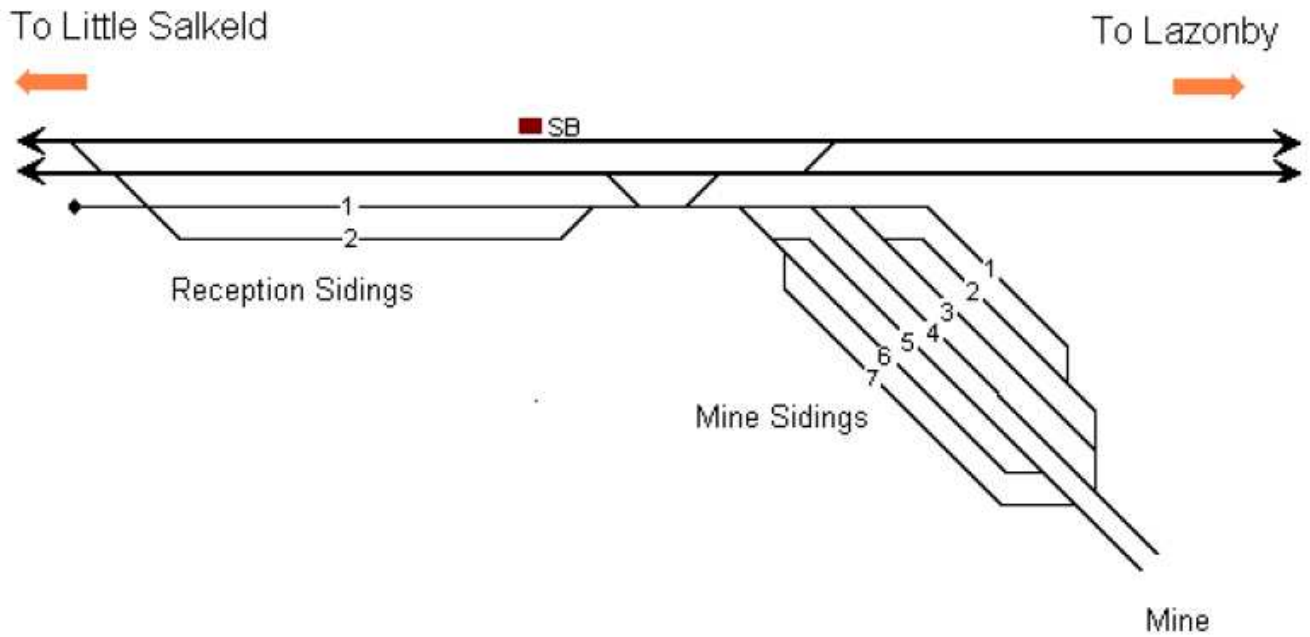

Lazonby

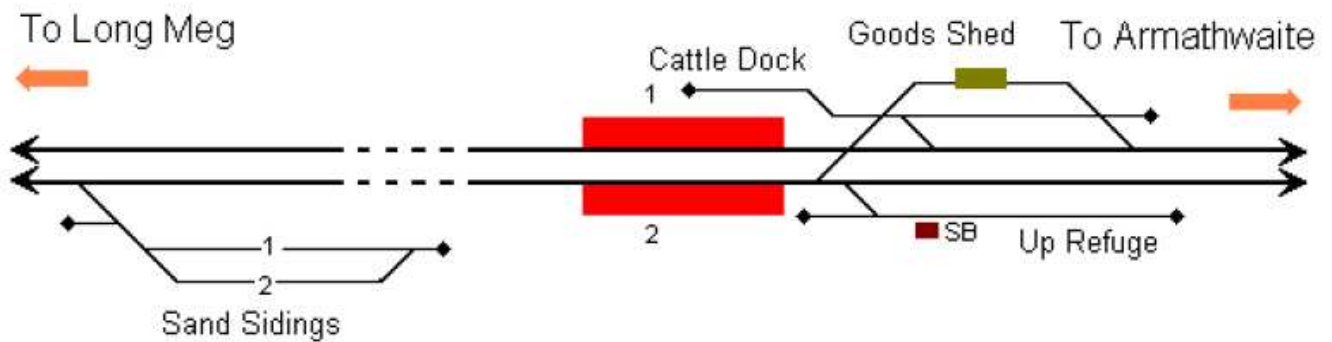

Armathwaite

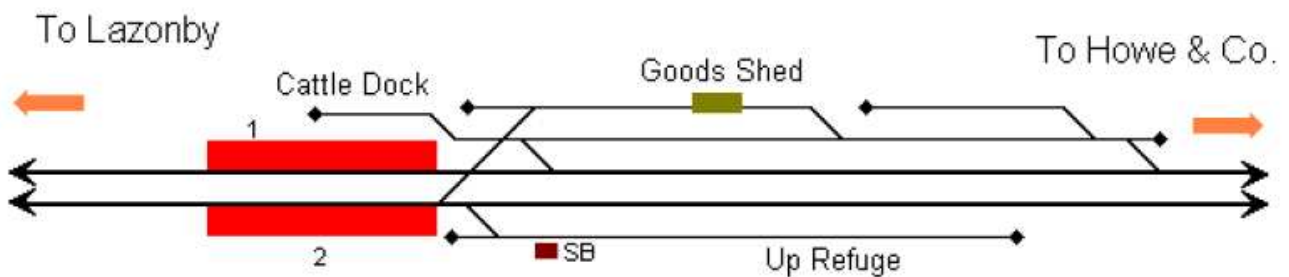

Howe & Co. Sidings

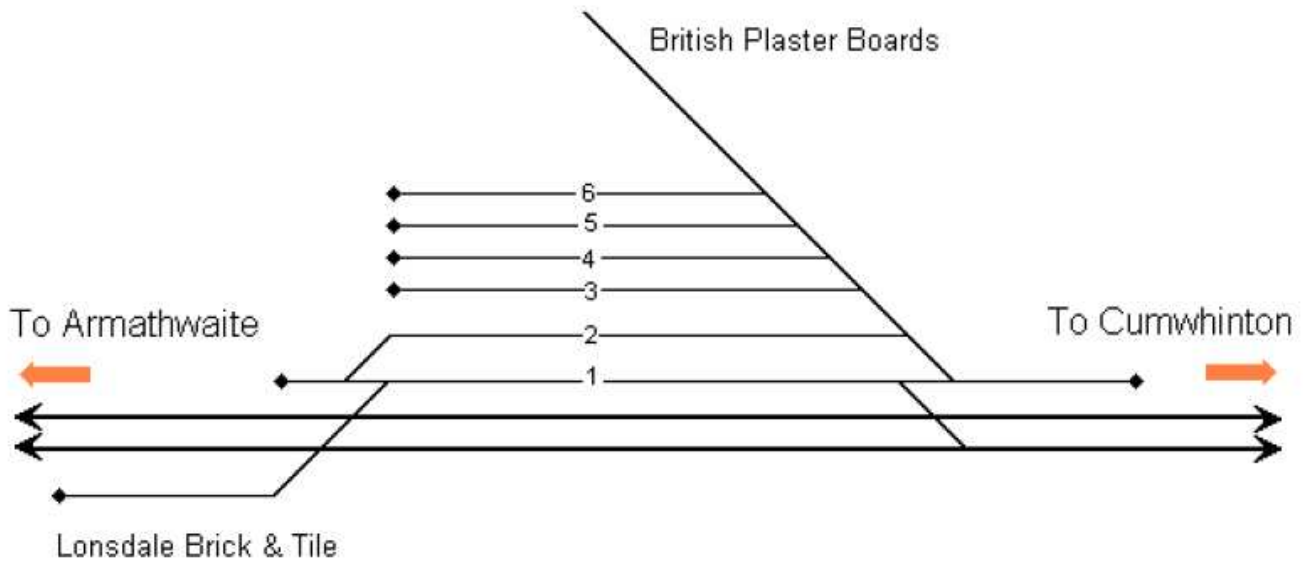

Cumwhinton

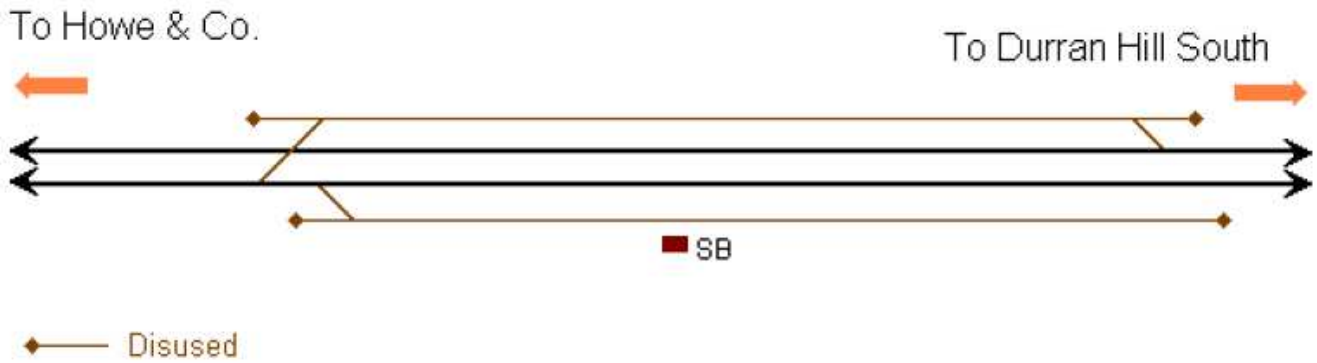

Durrant Hill South

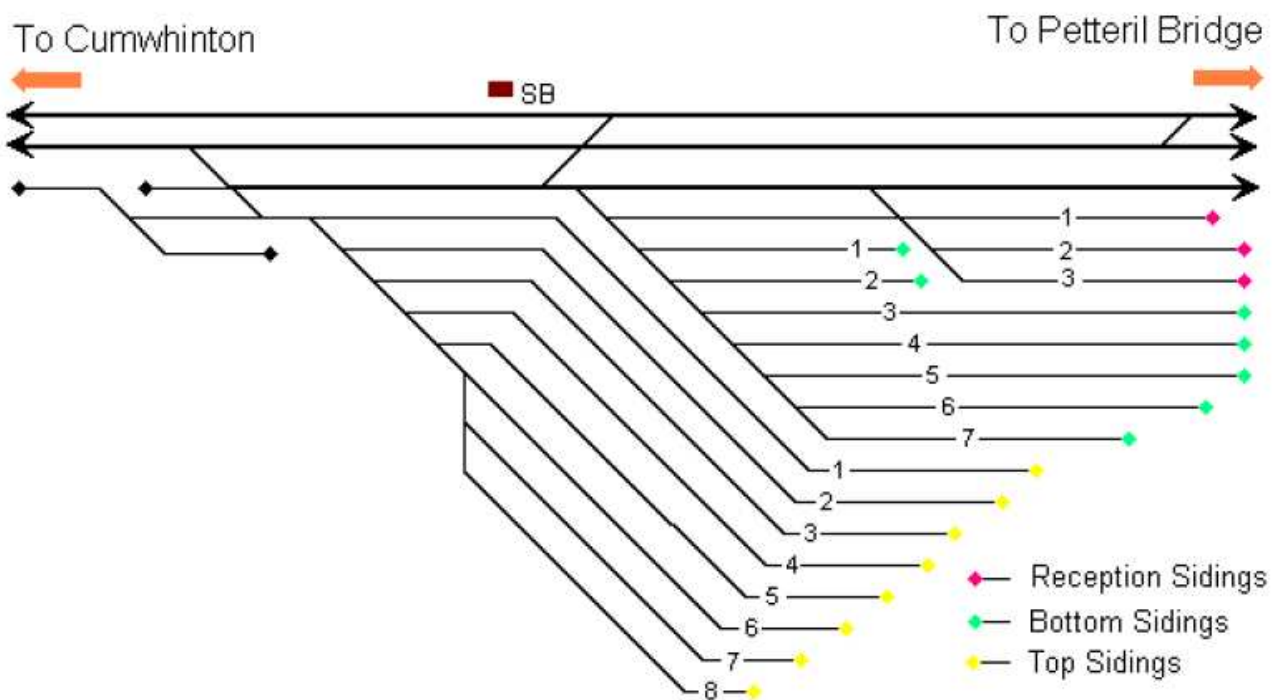

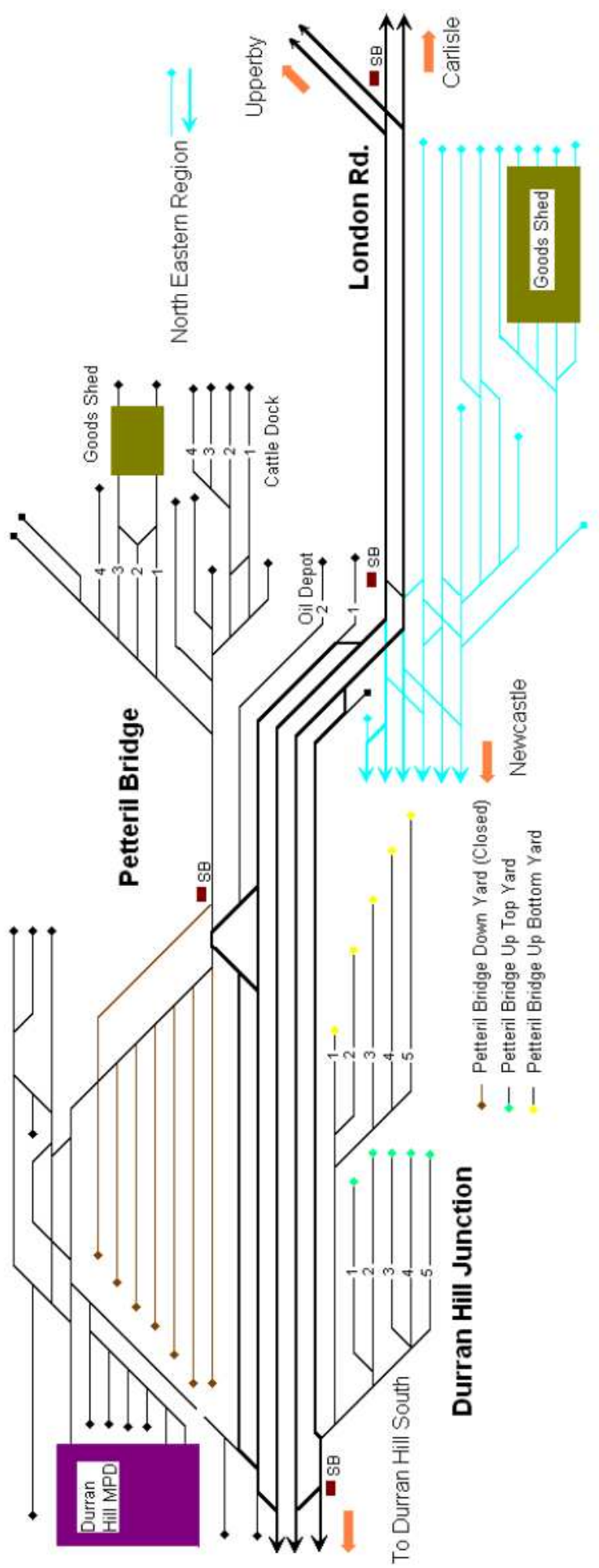

- Petteril Bridge Down Yard (Closed)
- Petteril Bridge Up Top Yard
- Petteril Bridge Up Bottom Yard

